

65 -2026

# CERTIFIED COPY OF ORDER

STATE OF MISSOURI

} ea.

February Session of the January Adjourned

Term. 20 26

County of Boone

In the County Commission of said county, on the

3rd

day of February

20 26

the following, among other proceedings, were had, viz:

Now on this day, the County Commission of the County of Boone does hereby approve the attached Budget Amendment #5 for Department 4130 (Law Enforcement Training Center) to cover owner costs.

Done this 3<sup>rd</sup> day of February 2026.

ATTEST:

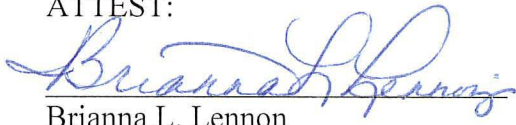
  
Brianna L. Lennon  
Clerk of the County Commission

  
Kip Kendrick  
Presiding Commissioner

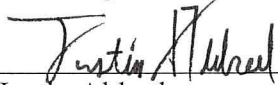
  
Justin Aldred  
District I Commissioner

  
Janet M. Thompson  
District II Commissioner

RECEIVED

JAN 14 2026

BOONE COUNTY AUDITOR

BOONE COUNTY, MISSOURI
REQUEST FOR BUDGET AMENDMENT

1/13/26

EFFECTIVE DATE

FOR AUDITORS USE

(Use whole \$ amounts)

Transfer From Decrease Transfer To Increase

Table with 6 columns: Dept, Account, Fund/Dept Name, Account Name, Transfer From Decrease, Transfer To Increase. Row 1: 4130, 71231, LE Training Ctr Construction, Owner Costs, , 71,215. Total: - , 71,215

Describe the circumstances requiring this Budget Amendment. Please address any budgetary impact for the remainder of this year and subsequent years. (Use an attachment if necessary):

BA #5 to increase Owner Costs for items on the attached spreadsheet

Requesting Official signature and name

TO BE COMPLETED BY AUDITOR'S OFFICE

- A schedule of previously processed Budget Revisions/Amendments is attached
A fund-solvency schedule is attached.
Comments: Cover Owner Costs #5

Auditor's Office signature and name

PRESIDING COMMISSIONER signature and name

DISTRICT I COMMISSIONER signature and name

DISTRICT II COMMISSIONER signature and name

BUDGET AMENDMENT PROCEDURES

- County Clerk schedules the Budget Amendment for a first reading on the commission agenda. A copy of the Budget Amendment and all attachments must be made available for public inspection and review for a period of at least 10 days commencing with the first reading of the Budget Amendment.
At the first reading, the Commission sets the Public Hearing date (at least 10 days hence) and instructs the County Clerk to provide at least 5 days public notice of the Public Hearing. NOTE: The 10-day period may not be waived.
The Budget Amendment may not be approved prior to the Public Hearing

Delivering to Columbia 29201  
Update location

All Insignia+10'+3-Outlet+Extension+Power+Cord+-+Black

Account & Lists  
Orders

Amazon.com | Amazon Hardware | Medical Care | Amazon Books | Best Sellers | Books | Computers | Gift Cards | Smart Home | Today's Deals | Home | Music | Amazon Home | Fashion | Sign in | Toys & Games | Sports & Outdoors

Electronics | New Arrivals | Deals | Cell Phones | Computers | TV & Video | Headphones | Office Electronics | Camera & Photo | Wearable Technology | Audio & Home Theater | New customer? Start here | Support | Video Games | Software

amazon business Shop Business Savings Event

Tools & Home Improvement | Electrical | Cords, Adapters & Multi-Outlets | Extension Cords

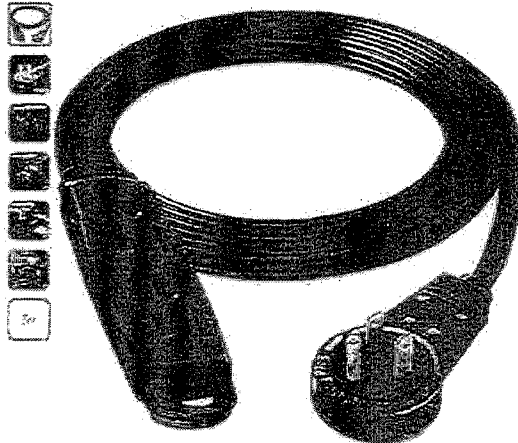

Click to see full view

## Maximm 360 Degree Rotating Flat Extension Cord 10 Ft Multi 3 Outlet Power Cord Grounded 16 AWG UL Certified, Black

Visit the Maximm Store

4.8 (1,801)

Amazon's Choice

\$17.45

Get Fast, Free Shipping with Amazon Prime  
FREE Returns

Get \$60 off instantly. Pay \$0.00 upon approval for the Amazon Store Card.

Size: 10 Feet

1 Foot 3 Feet 6 Feet 10 Feet

Color: Black

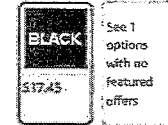

Color	Black
Brand	Maximm
Connector Gender	Male-to-Female
Voltage	125 Volts
Plug Format	Type B

### About this item

- 360 DEGREE ROTATING:** This Maximm extension cable is an exclusively designed top quality 360° degree rotating flat supply plug with 3 female outlet connectors for additional power outlets.
- SPACE SAVER:** Convert your standard AC power cord to a slim rotating flat plug, providing angular flexibility. Plug into the top outlet and still have usage of the bottom outlet with this rotating cord. Specially designed for tight spaces like behind furniture, bookshelves, desks or anything close to the wall not allowing you to use the standard outlet.
- MULTIPLE OUTLETS:** The female receptacle comes with 3 outlets giving you the option to plug in multiple devices or appliances thus having the same extension to three devices at once.
- CONVENIENCE:** Easily stored and even while in use can be leveled and hooked on for easier access for convenience.
- HIGH QUALITY:** Maximm is proud to provide the market with our highly rated exclusive design power extension cords made only of the highest of quality and durability materials and is surely approved by the UL providing the peace of mind of receiving the safest extension cables. Specs: 3-pronged outlets, grounded plug for safety and convenience, (NEMA 5-15P) to Multiple 3-Outlet (NEMA 5-15R) 3 Conductor Wire UL Certified Extension Cord, 13Amp 125Volt, 1625 Watts

### Additional Details

Small Business  
This product is from a small business brand. Support small. Learn more

Report an issue with this product or seller

### Consider a similar item

prime

Enjoy fast, free delivery, exclusive deals, and award-winning movies & TV shows.

Join Prime

\$17.45

Get Fast, Free Shipping with Amazon Prime

FREE delivery Monday, January 19 on orders shipped by Amazon over \$35

Or Prime members get FREE delivery Friday, January 16. Order within 9 hrs 16 mins. [Join Prime](#)

Delivering to Columbia 29201 - Update location

In Stock

Quantity: 1

[Add to cart](#)

[Buy Now](#)

Ships from: Amazon

Sold by: Maximm Cable

Returns: FREE 30-day refund/replacement

Payment: Secure transaction

Add a gift receipt for easy returns

[Add to List](#)

[Shop Iron Forge Cable](#)

Tools & Home Improvement **Electrical** [Cords, Adapters & Multi-Outlets](#) [Extension Cords](#)

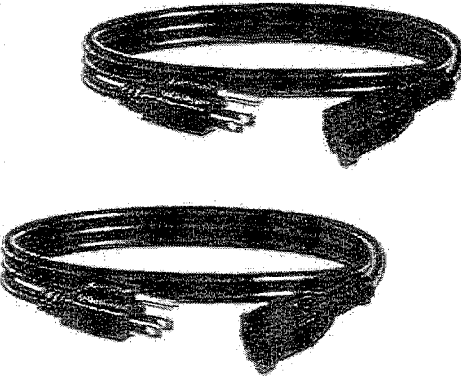

[Click to see full view](#)

### BN-LINK 6ft Indoor Outdoor Extension Cord 16/3 SJTW, 2 Pack, Black, 3-Prong, Weather Resistant & Flame Retardant, for Indoor, Garden, Landscaping & Holiday Decorations, ETL

Visit the BN-LINK Store

4.6 (669)

3 sustainability features

500+ bought in past month

Limited time deal

-15% **\$12.74**

List Price: ~~\$14.99~~

Get Fast, Free Shipping with Amazon Prime

FREE Returns

Get \$50 off instantly. Pay \$0.00 upon approval for the Amazon Store Card.

Color: **Black**



Size: **6FT 2PACK**

- 3FT 2PACK
- 3FT 3PACK
- 6FT 2PACK
- 6FT 3PACK
- 10FT 2PACK
- 15FT 2PACK

Bundles with this item

BN-LINK 6 ft Indoor Outdoor Extension Co...	3 ft & 6ft Indoor Outdoor Extension Co...	2x 6ft Outdoor Extension Cord 13A &...
-13% <b>\$19.93</b>	-25% <b>\$20.99</b>	-16% <b>\$22.98</b>
List: <del>\$22.60</del>	List: <del>\$27.66</del>	List: <del>\$27.48</del>

See all bundles

Color	Black
Brand	BN-LINK
Connector Gender	Male-to-Female
Voltage	125 Volts
Plug Format	Type B

#### About this item

- SAFE AND RELIABLE:** The BN-LINK 3 prong extension cord is built with a pure copper core, ensuring safe and reliable performance without overheating. It's perfect for powering outdoor tools and holiday decorations in any season.
- FLEXIBLE AND TANGLE-FREE:** The 6' outdoor extension cord features a 16/3 SJTW cable that remains flexible and resists tangling, making it easy to maneuver around your yard, garden, or workspace.
- DURABLE YEAR-ROUND:** This outdoor extension cord is waterproof and built to withstand various weather conditions, providing dependable power for your DIY electric tools, lawn mowers, and holiday decorations all year round.



Enjoy fast, free delivery, exclusive deals, and award-winning movies & TV shows.

Join Prime

**\$12.74**

Get Fast, Free Shipping with Amazon Prime

FREE delivery Monday, January 19 on orders shipped by Amazon over \$35

Or Prime members get FREE delivery Tomorrow, January 15. Order within 11 hrs 51 mins. [Join Prime](#)

Delivering to Columbia 65201 - [Update location](#)

In Stock

Quantity: 1

[Add to cart](#)

[Buy Now](#)

Ships from Amazon

Sold by BN-LINK

Returns FREE 30-day refund/replacement

Payment Secure transaction

Add a gift receipt for easy returns

[Add to List](#)

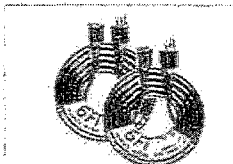

PlugSaf 2 Pack of 6ft Black Out...

4.7 1,424

**\$11.99**

Sponsored

Electronics › Television & Video › Accessories › Cables › HDMI Cables

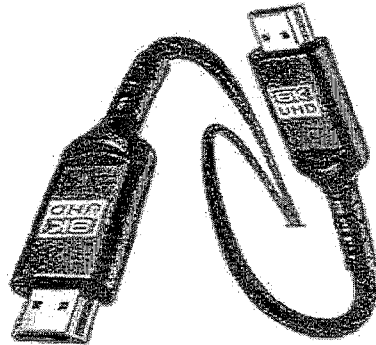

Click to see full view

### ALLEASA 8K HDMI 2.1 Cable 12ft, Certified 48Gbps Ultra High Speed Braided Cord, Supports 4K@120Hz 8K@60Hz, eARC HDR10+ HDCP 2.3, Compatible with PS5, Xbox Series X, Gaming PC, Roku TV & Monitor

Visit the ALLEASA Score

4.6 (1,928)

Shipped by Amazon

1K+ bought in past month

\$7.99

Get Fast, Free Shipping with Amazon Prime

FREE Returns

Save 5% on 2 select item(s) Shop items

Get \$60 off instantly: Pay \$0.00 upon approval for the Amazon Store Card.

Size: 12 Feet

2 Feet \$5.99	8 Feet \$7.99	12 Feet \$7.99	15 Feet \$15.99 <del>\$16.99</del>	20 Feet \$14.99	25 Feet \$15.99
30 Feet \$23.99					

Color: Red

Number of Items: 1

Brand	ALLEASA
Connector Type	HDMI
Cable Type	HDMI
Compatible Devices	Monitor, PC
Special Feature	High Speed

#### About this item

- ✦ **Ultra-High Definition Support**: Experience the future of home entertainment with our 8K HDMI cable that supports resolutions up to 7680x4320. Enjoy 8K @ 120Hz and 4K @ 120Hz for stunning clarity and flawless motion on compatible displays, perfect for movie enthusiasts and gamers alike.
- ✦ **Gaming Perfected**: Play without interruptions with our HDMI 2.1 cable featuring Variable Refresh Rate (VRR) to eliminate screen tearing and stuttering. Enhanced Audio Return Channel (eARC) ensures you hear every detail with rich, high-definition audio for an immersive gaming experience.
- ✦ **Sturdy & Reliable Design**: Constructed with 28AWG tinned copper and triple shielding, our 12ft HDMI cable is designed for durability. The unique non-locking buckle design prevents damage to your devices during disconnection, ensuring a long-lasting connection for all your entertainment needs.
- ✦ **Dynamic Visuals**: Immerse yourself in a multi-dimensional visual experience with Dynamic HDR and 3D capabilities. Our HDMI cable enhances color, contrast, and brightness on every frame, providing a lifelike viewing experience.
- ✦ **Lifetime Commitment**: Trust in ALLEASA's dedication to quality, as we offer lifetime after-sales service for your peace of mind. Our customer service team is ready to assist you with any inquiries or technical support, ensuring your satisfaction with every use.

Customers usually keep this item



Enjoy fast, free delivery, exclusive deals, and award-winning movies & TV shows.

Join Prime

\$7.99

Get Fast, Free Shipping with Amazon Prime

FREE delivery Monday, January 19 on orders shipped by Amazon over \$35

Or Prime members get FREE delivery Tomorrow, January 18. Order within 14 hrs 36 mins. Join Prime

Delivering to Columbia 63201 • Update location

In Stock

Quantity: 1

Add to cart

Buy Now

Ships from Amazon

Sold by ALLEASA US

Returns: FREE 30-day refund/replacement

Packaging: Ships in product packaging

See more

Add a gift receipt for easy returns

Add to List



Cable Matters [Ultra High Speed...

4.7 10,156

\$23.99

Delivering to Columbia 65202  
Update location

All ▾ microwave

EN ▾ Hello, sign in  
Account & Lists ▾ Returns  
& Orders 0

All Holiday Gifts Medical Care ▾

Books



Amazon Home Shop by Room Discover Shop by Style Home Décor Furniture Kitchen & Dining Bed & Bath Garden & Outdoor Home Improvement

Show 1 results

Sponsored

Home & Kitchen ▸ Kitchen & Dining ▸ Small Appliances ▸ Microwave Ovens ▸ Countertop Microwave Ovens



### HOW TO OPEN THE DOOR

Due to changes in the applicable third-party safety standard, all manufacturers are required to add this two-step child lock safety feature to all countertop microwaves sold in the USA or Canada to comply with the standard.

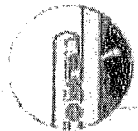

1. Pull upwards and hold the release trigger

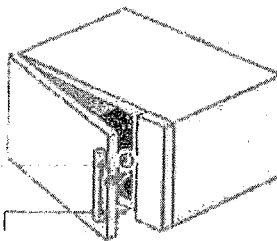

2. Pull handle to open

TOSHIBA

Click to see full view



## TOSHIBA ML-EM09PA(BS) Small Microwave Oven with 6 Auto Menus, Mute Function & Child Lock, LED Lighting, Perfect for Apartment, 0.9 Cu Ft, 10.6 Inch Removable Turntable, 900W, Black Stainless Steel

Visit the TOSHIBA Store

4.4 (52,489)

Amazon's Choice

5K+ bought in past month

-12% **\$103<sup>36</sup>**

List Price: ~~\$117.99~~

FREE Returns

Get \$60 off instantly. Pay \$43.36 upon approval for the Amazon Store Card

Available at a lower price from other sellers that may not offer free Prime shipping.

Size: **Advanced-0.9 Cu Ft-900W-Black...**

<b>ChefDefrost-0.7 Cu Ft...</b>	<b>Sensor-2.2 Cu Ft...</b>	<b>Advanced-0.9 Cu Ft...</b>
\$83.30 <del>€99.99</del>	\$224.09	\$103.36 <del>€117.99</del>

**Advanced-0.9 Cu Ft...**  
\$102.00  
~~€117.99~~

See 2 options with no featured offers

<b>Brand</b>	TOSHIBA
<b>Product Dimensions</b>	14.7"D x 18.7"W x 10.7"H
<b>Color</b>	Black Stainless Steel
<b>Capacity</b>	0.9 Cubic Feet
<b>Special Feature</b>	Child Safety Lock, Control Panel Lock, Defrost, One Touch

See more

### About this item

- Two-Step Child Lock: This mandatory safety feature for microwaves helps prevent unintended use by younger family members, please open the machine according to the steps shown in the figure.



Enjoy fast, free delivery, exclusive deals, and award-winning movies & TV shows.

Join Prime

Buy new: **\$103<sup>36</sup>**

FREE delivery Wednesday, December 10. Order within 12 hrs 1 min

Delivering to Columbia 65202 - Update location

In Stock

Quantity: 1

Add to Cart

Buy Now

Shipper / Seller Amazon.com

Returns FREE refund/replacements at no cost.

Support Product support included

See more

### Add a Protection Plan:

- 3-Year Protection Plan for \$21.99
- 4-Year Protection Plan for \$29.99
- Complete Protect: One plan covers all eligible past and future purchases for \$16.99/month
- Add a gift receipt for easy returns

Save with Used - Like New **\$93<sup>40</sup>**

FREE delivery Wednesday, December 10

Ships from: Amazon  
Sold by: Amazon Resale

## Leasa Quick

---

**From:** Jody Moore  
**Sent:** Thursday, January 8, 2026 2:38 PM  
**To:** Leasa Quick; Brian Leer  
**Subject:** Scrubber for Training Facility and Shooting Range

Leasa and Brian,

After discussion of the areas that would need to be cleaned utilizing a floor scrubber and the desire for durability of the product, I would recommend the purchase of a Karcher Chariot 2 iScrub stand on floor scrubber. A new Karcher was purchased from Q4 Industries in 2024 for the Courthouse. The purchase was made via contract PCA OD-305-20. The specific model purchased at that time was a Chariot 2 iScrub 22SP, including AGM batteries, brushes and on-board charging. At that time, the new scrubber was purchased at a cost of \$16,368. This scrubber provides ease of use, as well as allowing for expedited cleaning time. This model can scrub up to 19,700 square feet per hour.

In looking at this same piece of equipment on several sites, it would be wise to estimate an increase of about 20% in price. Online costs are now currently upwards of \$19,000. If Purchasing is able to once again obtain this piece of equipment utilizing a cooperative contract, the pricing may be slightly less than the pricing from online vendors.

Below is an online snapshot of the equipment as priced through Webstaurant.

# Scrubber with (3) 114 Ah AGM Batteries, On-Board Chai 10 Gallon, 36V, 1,500 RPM

Scrubber with (3) 114 Ah AGM Batteries, On-Board Chai

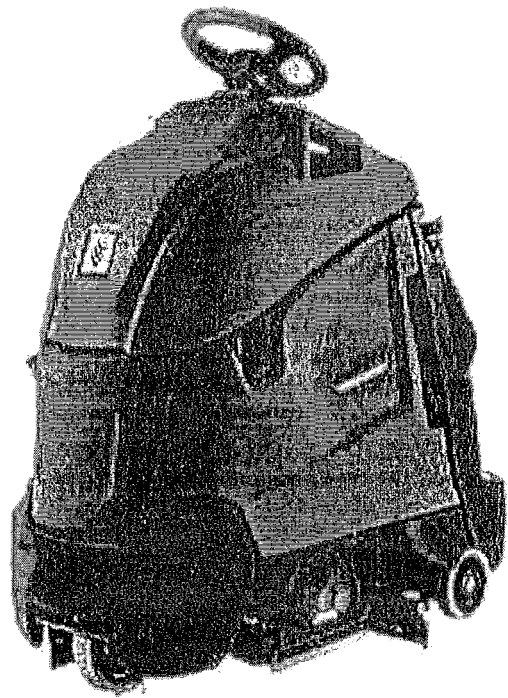

I hope this information is helpful.

Jody

**Jody Moore**  
Deputy Director  
Facilities Management  
573-886-7221  
jmoore@boonemo.gov

*"You're never ready for what you have to do. You just do it. That makes you ready."*



1-800-295-5510

Search



Products Uline Brand Quick Order Catalog Request Special Offers About Us Careers

Home > All Products > Material Handling > Hand Trucks > Uline Convertible Steel Hand Trucks

## Uline Convertible Steel Hand Truck - Solid Wheels

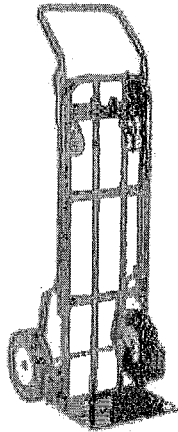

2-in-1 platform or hand truck.

- Converts in seconds. Just press and release bar.
- Capacity: 700 lbs. hand truck; 1,000 lbs. platform.
- 53" high, 10" wheels.
- 14 x 7 1/2" nose plate.
- Platform size: 14 x 43 1/4" (W x L).

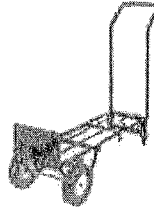

[More Images & Video](#)

MODEL NO.	HANDLE TYPE	WHEEL TYPE	LOAD CAPACITY (LBS.)	HEIGHT	WT. (LBS.)	PRICE EACH		IN STOCK SHIPS TODAY	
						1	3+	1	ADD
H-966	Continuous	10" Solid Rubber	700/1,000	53"	53	\$245	\$225	1	ADD

SHIPS ASSEMBLED VIA MOTOR FREIGHT

[Additional Info](#) [Parts](#) [Shopping Lists](#) [Request a Catalog](#)

HUGE SELECTION

LEGENDARY SERVICE

FASTEST DELIVERY

# INDEX

RESTAURANT  
SUPPLY

# Quote

01/08/2026

Project:  
BOONE COUNTY SHERIFF  
BRIAN 573-875-1111

From:  
Index Restaurant Supply  
JIM PAPPAS  
521 Main St.  
Kansas City, MO 64105-1224  
816-842-9122

Item	Qty	Description	Sell	Sell Total
2	2 ea	<b>COFFEE BREWER</b> BUNN Model No. 38700.0002 38700.0002 AXIOM®-15-3 Coffee Brewer, 200 oz. capacity tank, with 3 lower brewer warmers, brews 4.2 gallons per hour, hot water faucet, SplashGard® funnel, LCD display, automatic warmer shut-off, 120v/60/1-ph, 1.8kW, 15 amps, NEMA 5-15P, UL, NSF	\$892.00	\$1,784.00
	2 ea	Prices include applicable tariffs		
	2 ea	56000.0024 56000.0024 System, WEQ-10(1.5)5L	\$165.50	\$331.00
	6 ea	42400.0101 42400.0101 Decanter, 64 oz., glass, black handle (call for pricing on orders over 239 decanters)	\$10.70	\$64.20
			<b>ITEM TOTAL:</b>	<b>\$2,179.20</b>
			Total	\$2,179.20

Quoted pricing is good for 30 days.

### Warranties:

All standard manufacturers warranties are included. No other warranty applies unless otherwise noted above.

### Taxes:

Any applicable taxes are not included and are subject to the current rate at the time of final invoicing and are the responsibility of the customer.

### Payment Terms:

Unless otherwise noted standard payment terms are 50% due at signing of quote and acceptance of terms and conditions. An additional 45% of the total quote amount will be due when we receive the items and prior to delivery. The final 5% will be due on the day the customer takes possession of equipment described in quote. Payments greater than \$3,000 made with a credit card will be subject to a 3% upcharge.

**Returns/Exchanges:**

All returns and exchanges are subject to manufacturers restocking fee. Fees vary depending on specific manufacture policy. All fees will be explained in detail to customer before processing request.

**Freight:**

Unless specified otherwise, pricing does not include freight charges and they may need to be added. Any freight quoted is an estimate only. All standard shipments are curbside delivery only, unless otherwise specified. This means that the delivery driver will only drive the equipment to the property nearest the entrance. If you do not have a "semi-truck high" receiving dock, or own a forklift, you must request a liftgate delivery service at the time of purchase. A fee will need to be added if a liftgate is needed at the time of purchase.

**Delivery:**

Inside Delivery, including uncrating and setting in place, can be provided by Index. Pricing is done on a case by case basis and is to be determined. Index will not remove doors, windows or existing equipment to perform install unless otherwise noted in scope of work.

**Customer Responsibility:**

Customer is responsible for confirming all measurements, direction of operation, voltages and utility specifications prior to ordering. Any changes after ordering may incur a price adjustment. Please read and review this quotation carefully as it is based upon our understanding of items being requested. Please check quote for errors, omissions or inaccuracies of any kind.

**Execution:**

To accept the terms listed above and to move forward with the quotation please sign and return this entire document to your Index representative. No orders shall be placed until customers approves the quotation

Acceptance: \_\_\_\_\_ Date: \_\_\_\_\_  
Printed Name: \_\_\_\_\_

# AXIOM®-DV-3 (3 Lower Warmers)

Height: 16.8" (42.7cm)  
 Width: 16.3" (41.4cm)  
 Depth: 22.1" (56.1cm)



- Adjusts automatically to varying water pressure
- Automatic warmer shut-off
- For high lime areas, BrewLOGIC® technology calculates flow rate and adjusts brew time to maintain consistent pot levels
- Electronic diagnostics and built-in tank drain make service easier
- Ensure coffee quality with programming for brew level, cold brew lock-out and tank temperature, set easily from the front of the machine
- Coffee extraction controlled with programmable pre-infusion, pulse brew and digital temperature control
- Large 200oz. (5.9L) tank provides back-to-back brewing capacity
- Energy-saver mode reduces tank temperature during idle periods
- Hot water faucet
- SplashGard® funnel deflects hot liquids away from the hand
- Dual voltage adaptable (Can operate at 120V/15 amp or 120/208-240V/20 amp)
- PROP 65 Warning Decal Included in packaging with equipment
- Servers not included unless otherwise noted

⚠ Server(s) sold separately

Agency:



## Specifications

Product #: 38700.0009

Faucet: Upper

Water Access: Plumbed

Warmers: Three Lower

Finish: Stainless

Funnel: Black Plastic

## Additional Features

DBC

## Electrical & Capacity

Volts*	Amps	Watts	Cord Attached	Plug Type	8oz cups/hr 236ml cups/hr	Input H <sub>2</sub> O Temp.	Phase	# Wires plus Ground	Hertz
120	15	1800	Yes	NEMA 5-15P	67	60°F (15.5°C)	1	2	60
120/208	16	2080	-	N/A	121	60°F (15.5°C)	1	3	60
120/240	18	3880	-	N/A	121	60°F (15.5°C)	1	3	60

\*When a BUNN machine is marked 120/208-240V, 150/208V or 120/240V, the higher voltage is the supply voltage needed to power the machine. The 120V is there to supply power to some components rated 120V in the machine, but it is not the supply voltage and would not power the machine if the machine is marked with the higher mentioned voltages.

## Plumbing Requirements

## CAD Drawings

PSI	kPa	Fitting Supplied	Water Flow Required (GPM)	2D	Revit	KLC
20-80	138-621	1/4" Male Flare Fitting	-	•		

⚠ WARNING: This product can expose you to chemicals including Bisphenol A (BPA), which is known to the State of California to cause birth defects or other reproductive harm. For more information go to [www.P65Warnings.ca.gov](http://www.P65Warnings.ca.gov)



BUNN® reserves the right to change specifications and product design without notice. Such revisions do not entitle the buyer to corresponding changes, improvements, additions or replacements for previously purchased equipment. For most current specifications and other info visit [bunn.com](http://bunn.com).

Last Updated  
03/13/2025

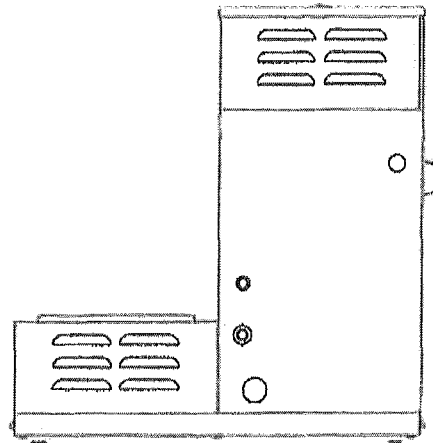
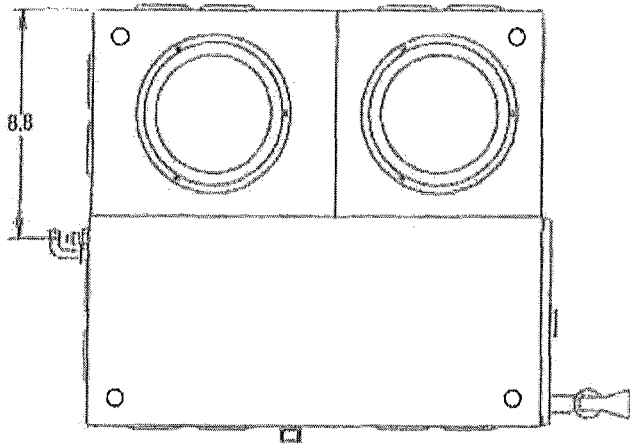

SOME MODELS

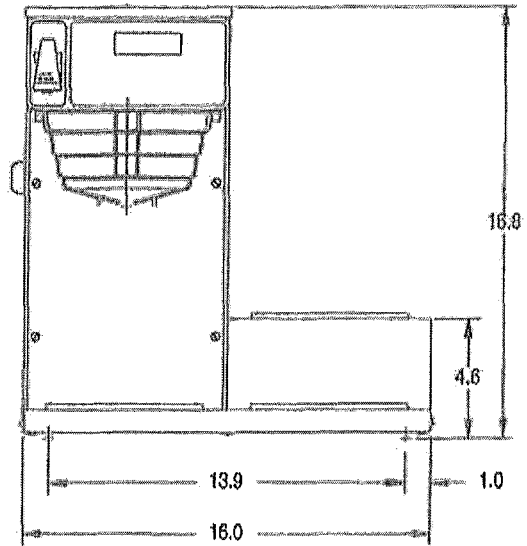
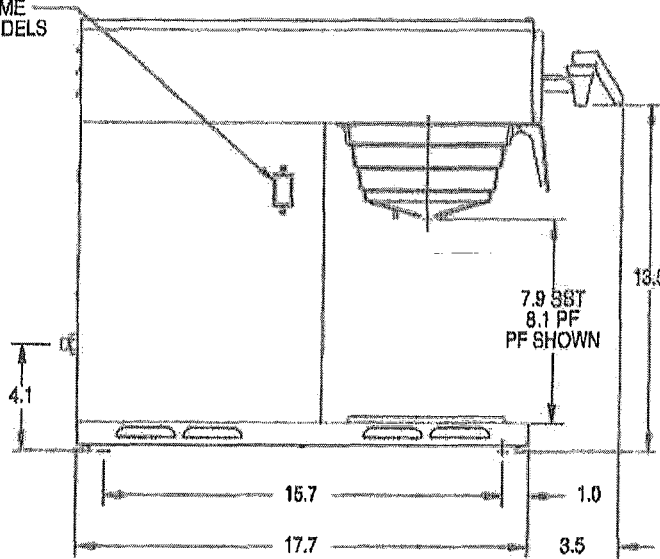

	Unit			Shipping				
	Height	Width	Depth	Height	Width	Depth	Weight	Volume
English	16.8 in.	16.3 in.	22.1 in.	22.4 in.	19.9 in.	25.8 in.	38,100 lbs	6.643 ft <sup>3</sup>
Metric	42.7 cm	41.4 cm	56.1 cm	56.8 cm	50.5 cm	65.6 cm	17,282 kgs	0,188 m <sup>3</sup>



BUNN® reserves the right to change specifications and product design without notice. Such revisions do not entitle the buyer to corresponding changes, improvements, additions or replacements for previously purchased equipment. For most current specifications and other info visit [bunn.com](http://bunn.com).

Last Updated:  
03/13/2025

Related Products & Accessories: AXIOM®-DV-3 (3 Lower Warmers)(38700.0009)

 <p>FUNNEL W/DECAL, PPK NAR BLK(SM)</p> <p>Product #: 02774.0011</p>	 <p>FUNNEL W/DECAL, PPK NAR BLK(LG)</p> <p>Product #: 04274.0012</p>	 <p>FILTERS, REGULAR 1M 500/2 50/CL</p> <p>Product #: 20115.0000</p>	 <p>FUNNEL ASSY, SST-BLK HDL(7.12)</p> <p>Product #: 20216.0000</p>	 <p>FUNNEL W/DECALS, BLACK PLASTIC</p> <p>Product #: 20583.0003</p>
 <p>FUNNEL ASSY, SST-PP BLK HDL</p> <p>Product #: 29151.0000</p>	 <p>FUNNEL ASSY, SST-PP ORANGE HDL</p> <p>Product #: 29151.0001</p>	 <p>WATER FILTER SYSTEM, EQ-17-TL</p> <p>Product #: 30200.1000</p>	 <p>WATER FILTER, IN LINE ED-17-TL</p> <p>Product #: 30201.1001</p>	 <p>SYSTEM, WEQ-10(1.5)5L</p> <p>Product #: 56000.0024</p>
 <p>CARTRIDGE, WEQ-10 (1.5)5L</p> <p>Product #: 56000.0121</p>	 <p>CARTRIDGE, WEQ-10.3 (1.67)5L</p> <p>Product #: 56000.0137</p>			



BUNN® reserves the right to change specifications and product design without notice. Such revisions do not entitle the buyer to corresponding changes, improvements, additions or replacements for previously purchased equipment. For most current specifications and other info visit [bunn.com](http://bunn.com).

Last Updated  
09/16/2025

Serving & Holding Options: AXIOM®-DV-3 (3 Lower Warmers)(38700.0009)

 <p>EASY POUR®,(BLK) 1/CS Product #:06100.0101</p>	 <p>EASY POUR®,(BLK) 2/CS Product #:06100.0102</p>	 <p>EASY POUR®,(BLK) 3/CS Product #:06100.0103</p>	 <p>EASY POUR®,(BLK) 6/CS Product #:06100.0106</p>	 <p>EASY POUR®,(BLK) 12/CS Product #:06100.0112</p>
 <p>EASY POUR®,(BLK) 24/CS Product #:06100.0124</p>	 <p>EASY POUR®,(ORN) 1/CS Product #:06101.0101</p>	 <p>EASY POUR®,(ORN) 2/CS Product #:06101.0102</p>	 <p>EASY POUR®,(ORN) 3/CS Product #:06101.0103</p>	 <p>EASY POUR®,(ORN) 24/CS Product #:06101.0124</p>
 <p>DECANTER, GLASS-BLK 12C 24/CS Product #:42400.0024</p>	 <p>DECANTER, GLASS-BLK 12CUP 1PK Product #:42400.0101</p>	 <p>DECANTER, GLASS-BLK 12C 3/CS Product #:42400.0103</p>	 <p>DECANTER, GLASS-ORN 12C 24/CS Product #:42401.0024</p>	 <p>DECANTER, GLASS-ORN 12 CUP 1PK Product #:42401.0101</p>
 <p>DECANTER, GLASS-ORN 12C 3/CS Product #:42401.0103</p>				



BUNN® reserves the right to change specifications and product design without notice. Such revisions do not entitle the buyer to corresponding changes, improvements, additions or replacements for previously purchased equipment. For most current specifications and other info visit [bunn.com](http://bunn.com).

Last Updated  
03/13/2025



1-800-265-5510

Search



[Products](#)

[Uline Brand](#)

[Quick Order](#)

[Catalog Request](#)

[Special Offers](#)

[About Us](#)

[Careers](#)

[Continue Shopping](#)

## Shopping Cart

[Empty Cart](#) | [Share](#)

Add Product by Model #

Model #	Description	Qty	Price	Total	Remove
H-3475	Microfiber Deluxe Dust Mop Kit - 48"	2	\$49.00/EA	\$98.00	
H-3474	Microfiber Deluxe Dust Mop Kit - 36"	2	\$43.00/EA	\$86.00	
				<b>SUBTOTAL = \$184.00</b>	

[Update](#)

[Checkout](#)

[Shipping](#) | [Sale Code:](#)

[Add](#)

\$300+ orders are eligible for a free item.



### Cart

#### Order Summary

Subtotal	\$284.53	Estimated Tax	N/A	Estimated Shipping	\$188.99
----------	----------	---------------	-----	--------------------	----------

Estimated Total \$473.52

	APPROVED VENDOR Boot Brush: 9 in L x 6 in W x 5 in H, Footwear, Frame, 9 in Lg Item # 8DAX6	Qty 4	Web Price \$56.76 / each
			<b>Total \$227.04</b>

Availability  
Expected to arrive **Wed. Jan 07.**

	RUBBERMAID COMMERCIAL PRODUCTS Push Broom: 37 in Sweep Face, Soft, Synthetic, Gray Bristle, Wood Item # 498Z08	Qty 1	Web Price \$57.49 / each
--	--	----------	-----------------------------

Availability  
Expected to arrive **Wed. Jan 07.**  
This item requires special shipping, additional charges may apply.

#### Products You Have Recently Viewed

	APPROVED VENDOR Boot Brush: 16-1/2 in L x 14-3/4 in W x 7 in H, Fram... Item # 9RZ71		APPROVED VENDOR Boot Brush: 9 in L x 6 in W x 5 in H, Footwear, Frame, 9 ... Item # 8DAX6		NOTRAX Boot Brush: 15 in L x 12 in W x 2 in H, Footwear, Base... Item # 52ZX91		RUBBERMAID COMMERCIAL PRODUCTS Push Broom: 37 in Sweep Face, Soft Synthetic, Gray Bristle, Wood Item # 498Z08
Web Price	<b>\$103.99</b> / each	Web Price	<b>\$56.76</b> / each	Web Price	<b>\$31.93</b> / each	Web Price	<b>\$57.49</b> / each
Qty 1	<a href="#">Add to Cart</a>	Qty 1	<a href="#">Add to Cart</a>	Qty 1	<a href="#">Add to Cart</a>	Qty 1	<a href="#">Add to Cart</a>



All

Tools & Home Improvement Best Sellers Deals & Savings Gift Ideas Power & Hand Tools Lighting & Ceiling Fans Kitchen & Bath Fixtures Smart Home Shop by Room

Shop Merbeay Shelf Liner

Sponsored

Home & Kitchen > Bath > Bathroom Accessories > Shower Curtains, Hooks & Liners > Shower Curtain Rods

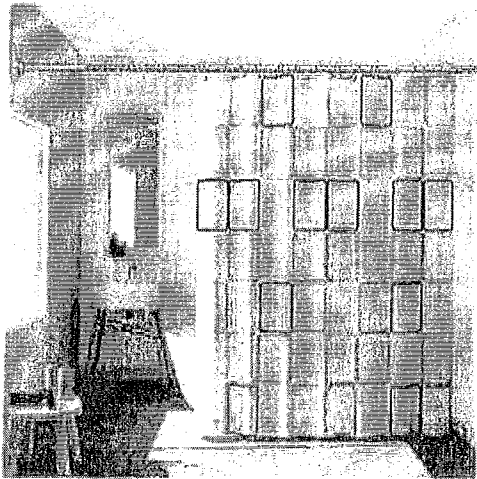

Click to see full view



3+

3 VIDEOS

### Umimile Shower Curtain Rod, 1 Inch Diameter Adjustable Spring Tension Curtain Rod, 304 Stainless Steel Shower Rod for Bathroom, Windows, Never Rust Non-Slip (Stainless Steel, 36-61")

Visit the Umimile Store

4.8 (129)

Amazon's Choice

50+ bought in past month

\$38.99

FREE Returns

Get \$60 off instantly: Pay \$0.00 upon approval for the Amazon Store Card.

Size: 36-61"

- 36-61"
- 42-70"
- 50-86"
- 57-100"

Color: Stainless Steel



\$37.99



\$38.99



\$37.99

Brand	Umimile
Color	Stainless Steel
Product Dimensions	36.01"L x 3"W
Material	Stainless Steel
Mounting Type	Tension Mounted
Item Weight	2.2 Pounds
Manufacturer	Umimile

#### About this item

- [Adjustable]** Transform your space with our adjustable shower curtain rod, extending from 36 to 61 inches. Just rotate the rod to effortlessly adjust the length—no tools or drilling needed!
- [Never Rust]** Our Shower Rod is expertly made from premium 304 stainless steel with a specialized anti-rust coating, ensuring it remains completely rust-free.
- [Durable & Strong Enough]** Our Tension Shower Curtain Rod exceptionally is sturdy with a premium feel, boasting a 1-inch diameter and 0.6mm thickness. It can support up to 37 pounds at its



Enjoy fast, free delivery, exclusive deals, and award-winning movies & TV shows.

Join Prime

\$38.99

FREE delivery Wednesday, December 10. Order within 11 hrs 17 mins

Delivering to Columbia 65202 - Update location

In Stock

Quantity: 1

Add to Cart

Buy Now

Ships from Amazon  
 Sold by melblan  
 Returns FREE refund/replacement until Jan 31, 2026  
 Payment Secure transaction

Add a gift receipt for easy returns

Add to List

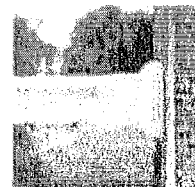

FurGreen Shower Curtain Rods S...

4.5 219

\$49.99

Sponsored



\$3,112.00



(https://www.range-systems.com)

PROJECT LOCATIONS  
(https://www.range-systems.com/project-locations/)

CONTACT US  
(https://www.range-systems.com/contact/)



Sale On All In Stock Eye And Ear Protection (https://www.range-systems.com/product-category/personal-protection/eye-and-ear-protection)

### Cart

Shipping costs updated.

	Product	Price	Quantity
<a href="https://www.range-systems.com/product/guardian-jr-clearing-trap/">(https://www.range-systems.com/product/guardian-jr-clearing-trap/)</a> <a href="https://www.range-systems.com/cart/?remove_item=eda80a3d5b344bc40f3bc04f65b7a3578&amp;wponce=5846aad9f6">https://www.range-systems.com/cart/?remove_item=eda80a3d5b344bc40f3bc04f65b7a3578&amp;wponce=5846aad9f6</a>	Guardian Jr.™ Gun Clearing Trap (https://www.range-systems.com/product/guardian-jr-clearing-trap/)	\$499.00	4
<a href="https://www.range-systems.com/product/guardian-jr-floor-stand/">(https://www.range-systems.com/product/guardian-jr-floor-stand/)</a> <a href="https://www.range-systems.com/cart/?remove_item=1b0114c51cc532ed34e1954b5b9e4b58&amp;wponce=5846aad9f6">https://www.range-systems.com/cart/?remove_item=1b0114c51cc532ed34e1954b5b9e4b58&amp;wponce=5846aad9f6</a>	Guardian Jr.™ Floor Stand for Guardian Jr. (https://www.range-systems.com/product/guardian-jr-floor-stand/)	\$279.00	4

### Cart totals

Subtotal \$3,112.00

**Shipping** No shipping options were found for columbia, MO 65202.

Enter a different address 

**Tax** \$279.30

**Total** \$3,391.30

**Proceed to checkout**  
(<https://www.range-systems.com/checkout/>)

## SHOOTING RANGE EQUIPMENT

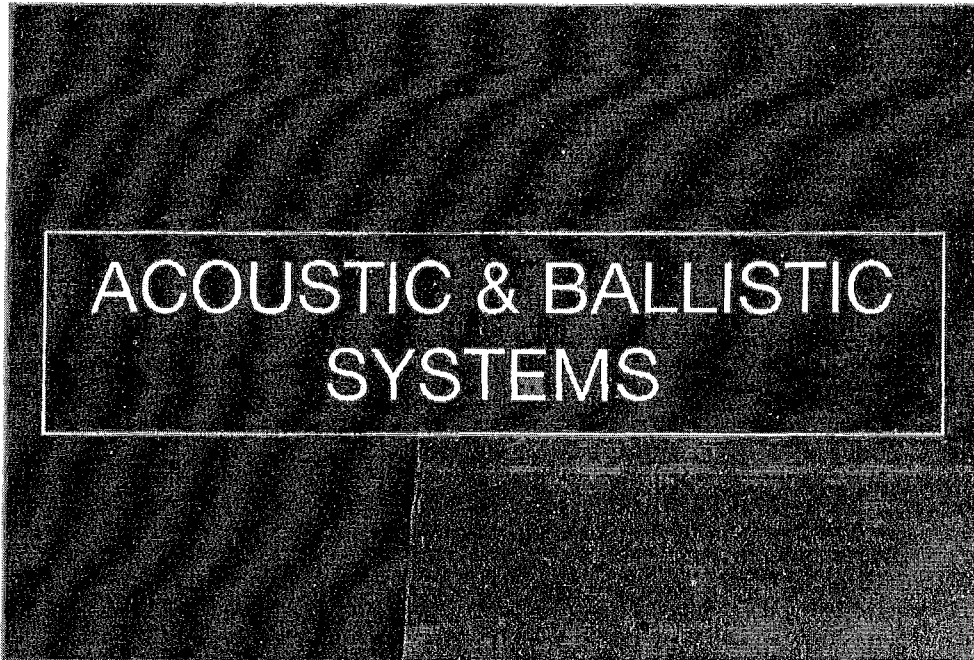

(<https://www.range->

[systems.com/ballistic-acoustic/](https://www.range-systems.com/ballistic-acoustic/))

## Shopping Cart (2)



**Tornado® Li-ion Battery For Strike Upright, Zephyr Backpack & Tempest Sweeper Vac, 36V, 7.5Ah**

Model #: WBB3177382

**\$485.95**

[Add to list](#)

[Save for later](#)

[Remove](#)

 Please Note: This item cannot be returned



**Tornado® Zephyr™ Cordless HEPA Backpack Vacuum, 3/4 Gallon Capacity**

Model #: WBB3177559

**\$669.00**

[Add to list](#)

[Save for later](#)

[Remove](#)

 Please Note: This item cannot be returned

## Products Related To Items In Your Cart

### Your Cart Summary

Item Total \$1,154.95

**Subtotal \$1,154.95**

Zipcode

Enter zipcode

**Total \$1,154.95**

Taxes are calculated during checkout.

Enter promo code



All Holiday Gifts Amazon Haul

Amazon Home Shop by Room Discover Shop by Style Home Décor Furniture Kitchen & Dining Bed & Bath Garden & Outdoor Home Improvement

Shop now

Sponsored

Industrial & Scientific › Janitorial & Sanitation Supplies › Floor Mats & Matting

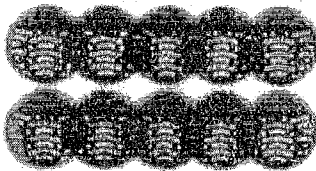

Click to see full view

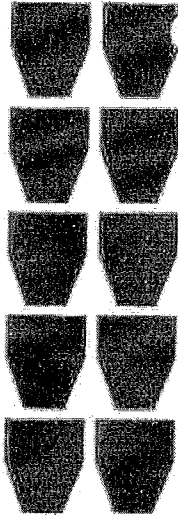

### 10 Pack Urinal Mats for Men + 10 Blue Urinal Screen Deodorizer, Non-Slip Urinal Floor Mats for Commercial Use, Highly Absorbent, Scented and Disposable Urinal Mats

Visit the JJ CARE Store

4.1 (72)

Amazon's Choice

50+ bought in past month

-7% \$64.89

Typical price: \$69.89

FREE Returns

Color Black

Brand JJ CARE

Special Feature Disposable

Pattern Solid

Product Care Vacuum or sweep regularly, spot clean with damp cloth as needed.

Instructions

**Material**  
Ethylene Vinyl Acetate (EVA), Polypropylene

**Shape**  
Rectangular

#### About this item

- **KEEPS THE TOILET AREA CLEAN** - JJ Care's Urinal Mats with Urinal Screen Deodorizer duo ensures fresh smelling and clean toilet areas every time. Stinky restaurant toilet areas and bathrooms should be a thing of the past - say no more to offensive odors and finally pee in cleanliness and comfort. The urinal floor mats with a urinal screen are the perfect duo for busy restrooms and bathrooms for men.
- **SAFE URINAL PADS** - Bathrooms can be dangerous places because of the slippery tiles. Men who frequent bars and clubs are at higher risk of slipping into the toilet after a few drinks. Create a safe urinal area for your male customers with this commercial bathroom urinal that has anti-skid and nonslip TPR backing. The urinal mats are kept in place and flat on any tile floor or smooth surface.



Enjoy fast, free delivery, exclusive deals, and award-winning movies & TV shows.

Join Prime

\$64.89

FREE delivery Thursday, December 11

Or fastest delivery Wednesday, December 10. Order within 9 hrs 5 mins

Delivering to Columbia 65202 - Update location

In Stock

Quantity: 1

Add to Cart

Buy Now

Ships from Amazon

Sold by JJ CARE

Returns FREE refund/replacement until Jan 31, 2026

Payment Secure transaction

Add a gift receipt for easy returns

Add to List

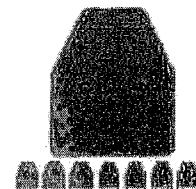

Urinal Mats (8 Pack) - Bathroom...

4.6 236

\$59.95

Sponsored

Delivering to Columbia 65202  
Update location

All amazon commercial plastic table 8 ft

EN Hello, sign in  
Account & Lists Returns & Orders

0

All Holiday Gifts Amazon Hauf Medical Care Luxury



Amazon Home Shop by Room Discover Shop by Style Home Décor Furniture Kitchen & Dining Bed & Bath Garden & Outdoor Home Improvement

Shop JNMDLAKO

SPONSORED

Home & Kitchen Furniture Game & Recreation Room Furniture Folding Tables & Chairs Folding Tables

### Lifetime 22980 Folding Utility Table, 8 Feet, White Granite, 96"''''

Visit the Lifetime Store

4.3 (196)

300+ bought in past month

\$138<sup>00</sup>

FREE delivery December 12 - 16. Order within 48 mins

Details

Delivering to Columbia 65202  
Update location

In Stock

Quantity: 1

Add to Cart

Buy Now

Shipper / Seller BobbyG LLC

Returns Returnable until Jan 31, 2026

Payment Secure transaction

#### Add a Protection Plan:

- 2-Year Protection Plan for \$27.99
- 3-Year Protection Plan for \$34.99
- Complete Protect: One plan covers all eligible past and future purchases for \$16.99/month

Add to List

#### Other sellers on Amazon

New (13) from \$137<sup>68</sup> & FREE Shipping



Bonilo Folding Table 8ft, Portab...

4.3 31

\$89<sup>99</sup>

Sponsored



Click to see full view



2+

SIZE

Color: White Granite

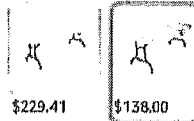

**Brand** LIFETIME  
**Product Dimensions** 30"D x 96"W x 29"H  
**Maximum Weight Recommendation** 2000 Pounds  
**Color** White Granite  
**Product Care Instructions** Clean with damp cloth

**Item Weight** 39.9 Pounds  
**Top Material Type** High Density Polyethylene  
**Frame Material** Wood  
**Shape** Rectangular

#### About this item

- Folds flat for easy storage and transport; Folded dimensions: 96" L x 30" W x 2.25" H
- Long-lasting powder-coated finish offers a reliable work or project table that's perfect for indoor and outdoor use.
- UV protected for outdoor use, provides extra seating and entertaining space, and cleans

Delivering to Columbia 65202  
Update location

All ▾ iceberg indestructible chairs

EN ▾

Hello, sign in  
Account & Lists ▾

Returns  
& Orders 0

Amazon Home

Shop by Room

Discover

Shop by Style

Home Décor

Furniture

Kitchen & Dining

Bed & Bath

Garden & Outdoor

Home Improvement

Shop Nazhura

Sponsored

Home & Kitchen ▸ Furniture ▸ Game & Recreation Room Furniture ▸ Folding Tables & Chairs ▸ Folding Chairs



Click to see full view

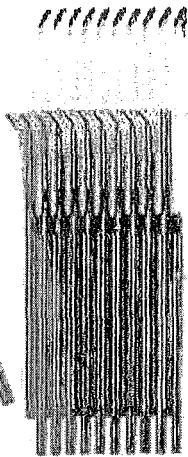

3+

6 VIDEOS

# Nazhura Heavy Chair Frame Outdoor Restaurant 10 Pack

Visit the [Nazhura](#) store

Amazon's

700+ bought recently

**\$219<sup>95</sup>** (\$22.00 / count)

Get \$60 off instantly. Pay \$159.95 upon approval for the Amazon Store Card.

Color: **White**

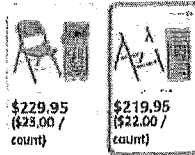

Size: **10 Pack**

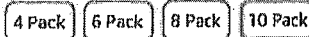

Brand **Nazhura**

Color **White**

Product **22.4"D x 19.3"W x 31.9"H**

Dimensions

Size **10 Pack**

Back Style **Open Back**

 **Material**  
Alloy Steel,  
Polypropylene

 **Item Weight**  
78 Pounds

 **Frame Material**  
Alloy Steel

 **Seat Material Type**  
Polypropylene

Shipper / Seller **PEARSONS1929**

Returns **Returnable until Jan 31, 2026**

Payment **Secure transaction**

### Add a Protection Plan:

- 2-Year Protection Plan for \$44.99
- 3-Year Protection Plan for \$56.99
- Complete Protect: One plan covers all eligible past and future purchases for \$16.99/month

Add to List

VINGLI Resin Folding Chairs with...

4.8 90

**\$109<sup>99</sup>**

Sponsored

### About this item

- **Premium Quality:** These folding chairs are made of high-quality PP (polypropylene) plastic, which is durable, sturdy, and resistant to wear and tear. The chairs can support weights up to 650 pounds, making them suitable for various indoor and outdoor activities.
- **Versatile Use:** The chairs are perfect for home, office, party, picnic, camping, and



# SAFETY

® RESTRAINT CHAIR INC.

...keeping people safe humanely®

☎ 712-263-5291

[CART](#)

## SUREGUARD® SAFETY RESTRAINT CHAIR

The SureGuard® Safety Restraint Chair is intended to help control combative, self destructive, or potentially violent detainees. If used properly it can reduce the risk of physical harm to both the detainee and staff. Violent behavior may mask dangerous medical conditions; therefore detainees must be monitored for and provided with medical treatment if needed. Detainees should not be left in the SureGuard® Safety Restraint Chair for more than two hours. The SureGuard® Safety Restraint Chair should never be used as a means of punishment.

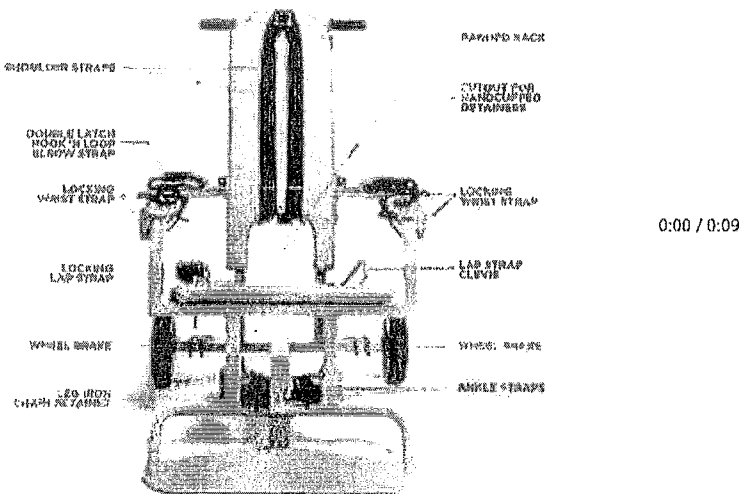

[VIEW VIDEO](#)

Featuring Secure, Locking Restraint Straps

[SPECIFICATIONS, Full-Sized Model](#) ▼

[SPECIFICATIONS, Junior-Sized Model](#) ▼

In order to save you money on shipping costs, please call us at 712-263-5291 for orders of 4 or more chairs.

Full Size Chair

\$3,100 each

Quantity:

ADD TO CART

### Junior Size Chair

\$3,050 each

Quantity: 1

ADD TO CART

CUSTOMERS IN CANADA ... for chairs or parts, please contact:

**SWS Detention Group Inc.**  
1-2120 Notre Dame Avenue  
Winnipeg, Manitoba R3H 0K1  
[sws@sws.ca](mailto:sws@sws.ca)  
1-877-797-1999

[Click to download SPEC SHEET](#) | [Click to download Junior SPEC SHEET](#) | [Click to download restraint instructions](#)

### SAFETY RESTRAINT CHAIR

...keeping people safe humanely®

HOURS: 9:00am to 4:00pm Central  
Monday through Friday

PHONE: 712-253-5291

[POLICIES](#)

[RESALER LOGIN](#)

Safety Restraint Chair, Inc. sells its products directly or through Authorized Resellers ONLY. We do not allow our products to be sold through unauthorized resellers, dealers, friends or any other method other than through us directly or through authorized resellers.

**YOUR BUSINESS ALLOWS US TO SUPPORT THESE ORGANIZATIONS:**

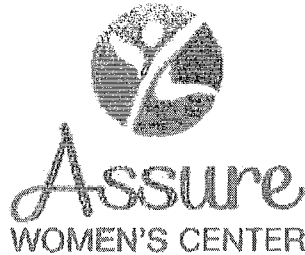

# Aaron Neugarten

**From:** Brian Leer  
**Sent:** Tuesday, January 13, 2026 4:29 PM  
**To:** Aaron Neugarten; Leasa Quick  
**Subject:** RE: RTC BA #5

Sorry Aaron. We forgot to print the shipping fees. Here they are:

restraintchair.com/ecart/shippingFreightTable.php

mer 202... CJIS Launch Pad LEISS Sign In - Audit Proof Informer.boonemo... Informer Online Grants Finan... Highway Safety Gra. Field Training Online Login | GETAC



### Remote Location Charges

Certain zip codes are considered remote locations for delivery, and a "per shipment remote location amount" will be included in the Freight amount shown below. If it applies for your zip code

### Logged In Resellers: PLEASE NOTE

- If you order Replacement Parts (*parts shipping is always done by Safety Restraint Chair*) along with your chair(s) order, you will see the Replacement amount on the next screen, included in Freight/Shipping
- Each Chair ordered by a LOGGED IN Reseller who chooses to arrange their own shipping will see a \$30 per chair Handling charge shown in Lift NEXT SCREEN.

Freight (MO)	\$485.00	(United States)
Lift Gate Service* -for chair orders only	<input checked="" type="checkbox"/>	\$65

\*Lift gate service is required if you do not have a loading dock. Uncheck box if you have a dock and don't require this service



**Captain Brian Leer**  
Boone County Sheriff's Office  
2121 County Drive  
Columbia, MO 65202  
(573) 875-1111 ext. 6428

**From:** Aaron Neugarten <ANeugarten@boonemo.gov>  
**Sent:** Tuesday, January 13, 2026 4:22 PM  
**To:** Leasa Quick <LQuick@boonemo.gov>  
**Cc:** Brian Leer <BLeer@boonemo.gov>  
**Subject:** RE: RTC BA #5

All,

I found 'Safety Restraint Chair, Inc.' estimate @ \$3,100. You have listed it at \$3,650. Is there a shipping cost I do not have? If so, please send me an estimate with this cost or I will take it down to \$3,100.

Let me know if you have any questions.



03:16  
pm  
Dec.  
4,  
2026

WEB DESIGN BY EDJE

**MENARDS - COLUMBIA**  
**3340 Vandiver Drive**  
**Columbia, MO 65202**

KEEP YOUR RECEIPT  
RETURN POLICY VARIES BY PRODUCT TYPE

Unless noted below allowable returns for  
items on this receipt will be in the form  
of an in store credit voucher if the  
return is done after 04/02/26

If you have questions regarding the  
charges on your receipt, please  
email us at:

COLMfrontend@menards.com



Sale Transaction

Cust name: German, Gary

Tax Exempt Certificate ID: 3108043  
Exempt Type: State or Local Government

ORDER 99844

27" PX 5-DWR BASE CAB-BL-PICK\*  
2114766 2 @279.99 559.98 NT  
END OF ORDER

Tax Exempt Certificate ID: 3108043  
Exempt Type: State or Local Government

ORDER 99843

72" PX WORKBENCH W/PEG-BL\*  
2114794 2 @339.99 679.98 NT

Tax Exempt Certificate ID: 3108043  
Exempt Type: State or Local Government

36" PX 2-DR TALL CAB-BLK\*  
2114774 329.99 NT  
END OF ORDER

TOTAL SALE 1569.95  
VISA CREDIT 0427 1569.95

PO #

Auth Code:072762

Chip Inserted

a0000000031010

ARQC - dea0b606003ed206

TOTAL SAVINGS 220.00

TOTAL NUMBER OF ITEMS = 5

GUEST COPY

The Cardholder acknowledges receipt of  
goods/services in the total amount shown  
hereon and agrees to pay the card issuer  
according to its current terms.

THIS IS YOUR CREDIT CARD SALES SLIP  
PLEASE RETAIN FOR YOUR RECORDS.

THANK YOU, YOUR CASHIER, Lindsey

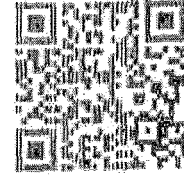
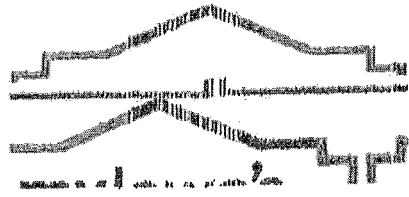

LEARN MORE AT [LOWES.COM/HVLOWESREWARDS](http://LOWES.COM/HVLOWESREWARDS)

LOWE'S HOME CENTERS, LLC  
201 MCNELEY RD  
COLUMBIA, MO 65201 (573) 499-6767

-- SFAI.LNE --

SALESM: S000000 4804734 TRANS#: 150858319 01-06-26

5615534 AIR ACALIA 10-FT 449.00

	SUBTOTAL:	449.00
	TOTAL TAX:	0.00
	INVOICE TOTAL:	449.00
	VISA:	449.00

VISA: XXXXXXXXXXXX0457 AMOUNT: 449.00 AUTHCD: 094664  
CHIP REFTD:00083320518 01/06/26 10:11:25  
TVF : 0000000000  
TSI : 0000

STORE: 0000 TERMINAL: 59 01/06/26 10:11:45

# OF ITEMS PURCHASED: 1  
EXCLUDES FEES, SERVICES AND SPECIAL ORDER ITEMS

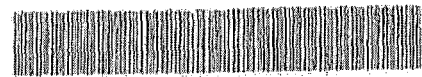

THANK YOU FOR SHOPPING LOWE'S.  
FOR FULL DETAILS ON OUR RETURN POLICY, VISIT  
[LOWES.COM/RETURNS](http://LOWES.COM/RETURNS)  
A WRITTEN COPY OF THE RETURN POLICY IS AVAILABLE  
AT OUR CUSTOMER SERVICE DESK

BY LOWE'S REWARDS (CREDIT CARDHOLDERS GET MORE).  
FOR DETAILS VISIT [LOWES.COM/HVLOWESREWARDS](http://LOWES.COM/HVLOWESREWARDS)

MENARDS - COLUMBIA  
3340 Vandiver Drive  
Columbia, MO 65202

KEEP YOUR RECEIPT  
RETURN POLICY VARIES BY PRODUCT TYPE

Unless noted below allowable returns for  
items on this receipt will be in the form  
of an in store credit voucher if the  
return is done after 04/07/26

If you have questions regarding the  
charges on your receipt, please  
email us at:  
COLMfrontend@menards.com



Sale Transaction

Tax Exempt Certificate ID: 3108043  
Exempt Type: State or Local Government

SUNNYSIDE MINERAL SPIRIT		
5613696	7.48	NT
6PK COTTON PAINT TOWELS		
5613576	3.69	NT
TACK CLOTH 4.5 SQ FT		
5613502 2 @0.99	1.98	NT
PURDY 2.5" WCB AS BRUSH		
5610510	15.48	NT
PURDY 3" WCB STRGHT BRUS		
5610520	17.98	NT
MINWAX POLYURETHANE SATI*		
5557817 2 @13.98	27.96	NT
TOTAL SALE	74.57	
VISA CREDIT 0427	74.57	

PO #

Auth Code:067943

Chip Inserted

a000000031010

ARQC - b549279e328e59bb

TOTAL SAVINGS 1.98

TOTAL NUMBER OF ITEMS = 8

GUEST COPY

The Cardholder acknowledges receipt of  
goods/services in the total amount shown  
hereon and agrees to pay the card issuer  
according to its current terms.

THIS IS YOUR CREDIT CARD SALES SLIP  
PLEASE RETAIN FOR YOUR RECORDS.

THANK YOU, YOUR CASHIER, Eb

93254 07 2222 01/07/26 11:59AM 3263



Enable Accessibility

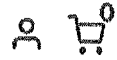

Q Search...

LAST CHANCE! 20% OFF REEBOK

Visit the Damascus store / Item# GL265 /

## Damascus Vector 1 Riot Control Gloves with Carbon-Tek Fiber Knuckles

0 (0) Ask a question

**\$70.20**

or 4 payments of 17.55 with sezzle



GET 15% OFF

SIZE **SELECT A SIZE** [SIZE CHART](#)

S M L XL XXL 3XL

1

**Add To Cart**

Add To Wishlist

## **Details**

### **Damascus Vector 1 Riot Control Gloves With Carbon-Tek Fiber Knuckles**

The Vector 1 Riot Control gloves by Damascus are expertly designed for high-risk operations such as civil disturbances or high-threat level situations that require superior hand protection. The gloves feature molded hard-shell Carbon-Tek fiber on the knuckles and panels to effectively deflect blows and flying debris. Adding to the protection, foam-injected padding is also included for the knuckles and wrist for superior comfort and safety. A leather shell with reinforced palms for an extra layer of protection. With double-reinforced stitching and an elasticized wrist fitted with Velcro closure, these gloves offer excellent durability and guarantee a secure and customized fit.

## **Specs**

- Molded hard-shell Carbon-Tek fiber knuckles and panels for superior protection
- Foam-injected padding for enhanced comfort and safety
- Durable leather shell with reinforced palms
- Double reinforced stitching for added durability
- Elasticized wrist with Velcro closure ensures a secure fit
- Inner lining consists of bonded breathable tricot for enhanced comfort

## You Might Also Like //

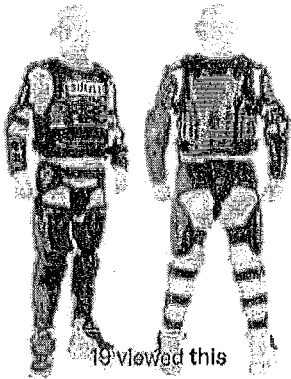

< Prev

19 viewed this

IN STOCK - READY TO SHIP

**Damascus FlexForce Full Body Protective Suit**

DAMASCUS

**\$657.00**

(4)

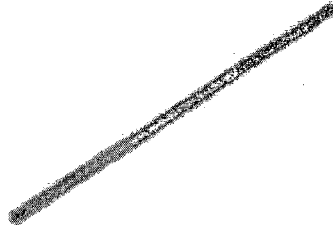

IN STOCK - READY TO SHIP

**Monadnock 36" Riot Baton Polycarbonate**

MONADNOCK

**\$102.99**

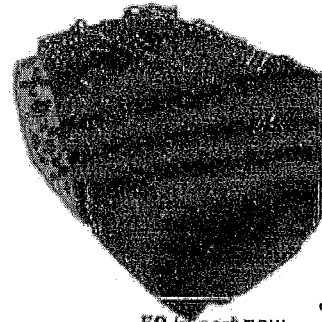

52 in cart now

> Next

IN STOCK - READY TO SHIP

**Damascus Riot Control Gear Bag**

DAMASCUS

**\$88.20**

## Reviews

**Review this Product**



Be the first to review this product



Enable Accessibility

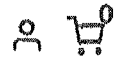

Q Search...



LAST CHANCE! 20% OFF REEBOK

Visit the Damascus store / Item# BP3220 / Mfg# DH1

### Damascus Riot Control Helmet with Visor

(0) Ask a question

**\$155.00**

or 4 payments of **38.75** with  sezzle 



GET 15% OFF

**COLOR** BLACK



**SIZE** SELECT A SIZE

S M/L XL

1

---

**Add To Cart**

Add To Wishlist

## **Details**

### **Damascus Riot Control Helmet With Visor**

The Damascus Gear Riot Control Helmet is a high-quality piece of protective equipment designed to shield your face and head from non-ballistic threats. This helmet boasts a high-impact ABS molded shell with an attached neck protector and a clear, tactical-grade polycarbonate face shield that is gasket sealed. The helmet straps on with a quick-release retention system that includes a chin cup. It offers comprehensive protection against various threats such as chemicals, rocks, bottles, and other projectiles. This riot control helmet is also compatible with most gas masks, making it suitable for a wide variety of emergency situations.

Mfg# DH1

MSRP: \$165.60

#### **Specs**

- High-impact resistant ABS thermoplastic composite shell
- Helmet liner made from 3/4" thick energy-absorbing polycarbonate
- Adjustable polycarbonate visor with thumb knobs and top gasket seal
- 3/4" chin strap with quick-release buckle and soft rubber chin cup

- Removable cervical neck protector
- Accepts most types of gas masks
- Scratch-resistant flat black finish
- Weighs 3.4 pounds
- Visor is 2.5mm thick

## You Might Also Like //

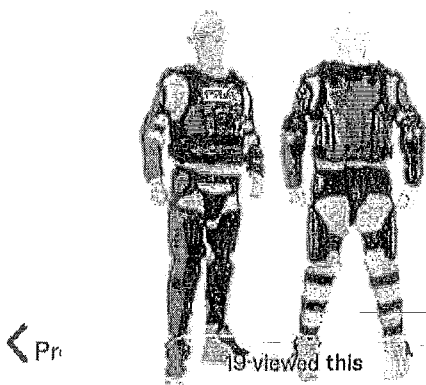

< Prev

19 viewed this



show

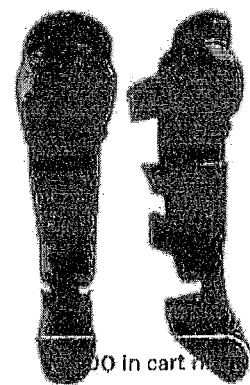

10 in cart

> Next

IN STOCK - READY TO SHIP

### Damascus FlexForce Full Body Protective Suit

DAMASCUS

\$657.00

(4)

IN STOCK - READY TO SHIP

### Damascus Elite Upper Body and Shoulder Protector

DAMASCUS

\$160.20

(2)

IN STOCK - READY TO SHIP

### Damascus Imperial Knee Sl Guards

DAMASCUS

\$76.99

(6)

## Reviews

### Review this Product



Be the first to review this product



Enable Accessibility

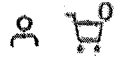

Q Search...

LAST CHANCE! 20% OFF REEBOK

Visit the Damascus store / Item# TE583 LG / Mfg# FX1 MPDEPT LG

### Damascus FlexForce Full Body Protective Suit

★★★★☆ 3.8 (4) Ask a question

**\$657.00**

or 4 payments of **164.25** with  sezzle 



GET 15% OFF

SIZE L

S

M

L

XL

XXL

3XL

**In Stock - Ready to Ship**

Please note: Must ship to law enforcement agency address. Click [Law Agency](#) for details.

1

**Add To Cart**

Add To Wishlist

## Details

### **Damascus FlexForce Full Body Protective Suit**

Step into the future of high-threat level protection with the FlexForce™ FX1 Hard Shell Crowd Control Suit from Damascus. Specifically designed for riot control, domestic disturbances, and cell extractions, this suit features hard shell front and back panels with a unique 3-panel flex design. This modular approach allows for versatile fit and optimum mobility, accommodating all shapes and sizes without compromising protection or comfort. Its lightweight, quick-donning design offers massive blunt-force trauma protection.

Upper Body And Shoulder Protector:

Mfg# FX1 MPDEPT LG

#### **Specs**

- Unique 3-panel flex design for optimum fit and comfort
- Electrum XK8™ hard shell front and back panels
- Cordura® nylon straps with Velcro® connection
- Shock-absorbing Protium™ foam for chest, back, shoulder and upper arms
- Breathable Polyester mesh lining

- Reflexive plate I.D. labels available separately
- Fastening with adjustable nylon and Velcro® straps

Forearm/Elbow Protectors:

- Flexible Electrum XK8™ shell for arm protections
- Protium™ foam covered with rugged Cordura nylon
- Comfortable and breathable polyester mesh lining
- Secure fastening with adjustable nylon elastic and Velcro®

Thigh/Groin Protector:

- Durable Electrum XK8™ outer shell on the thigh and hip
- Outer Protium™ foam with 150 denier Cordura nylon
- Comfortable and breathable polyester mesh lining
- Tailbone padding featuring Electrum XK8™ plastic laminated to Protium™ foam
- Groin protection with inner Electrum XK8™ shell and comfortable Protium™ foam padding
- Secure fastening with adjustable nylon and Velcro® straps

Knee/Shin Guards:

- Sturdy Electrum XK8™ knee caps and shin plates
- Heavy-duty Protium™ foam padded nylon for inner support
- Secure and comfortable fitting with multiple adjustable nylon elastic and Velcro® straps
- Non-reflective dull black finish on shin plates
- Removable, adjustable foot guards

Gear Bag:

- Compact dimensions with multiple storage compartments
- Detachable, cushioned shoulder strap
- Envelope pouches on bag sides
- Velcro® storage compartments in front

**You Might Also Like //**



Electronics

- New Arrivals
- Deals
- Cell Phones
- Computers
- TV & Video
- Headphones
- Office Electronics
- Camera & Photo
- Wearable Technology

Shop Nyaveez

Sponsored

Electronics > Computers & Accessories > Computer Accessories & Peripherals > Audio & Video Accessories > Computer Speakers

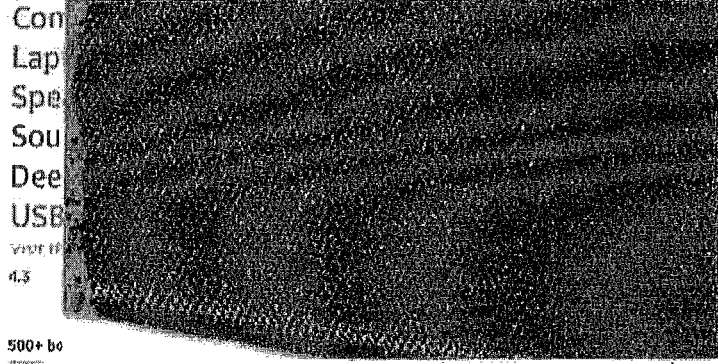
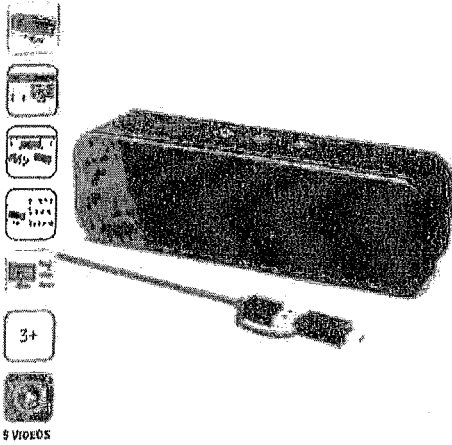

\$16.99 (\$1.27 / ounce)

Get Fast, Free Shipping with Amazon Prime  
FREE Returns

Coupons Apply 22% coupon Shop items > | Terms

Get \$60 off instantly. Pay \$0.00 upon approval for the Amazon Store Card.

Brand	XKX
Speaker	8 Watts
Maximum Output Power	
Connectivity Technology	USB, USB C
Audio Output Mode	Stereo
Mounting Type	Tabletop Mount

About this item

- [COMPATIBLE WITH USB DEVICES] - Our USB Speakers are designed to be compatible with a wide range of devices including Windows, macOS, ChromeOS, and Linux PCs, laptops, and desktop computers. We ensure seamless integration with your USB devices. Incompatible Devices: Monitors and TVs.
- [COMPATIBLE WITH USB-C DEVICES] - With the built-in USB C to USB Adapter, our USB C speakers now seamlessly support a wider range of devices featuring only the USB-C interface. This includes your new MacBook, Mac mini, iMac, iPad, Android phones, and tablets. We designed this adapter to ensure you can enjoy high-quality sound across all your favorite devices.
- [HIFI SOUND EXPERIENCE] - Our enhanced PC speaker boasts dual powerful speaker drivers along with a passive radiator, delivering surprisingly loud and clear sound with punchy bass from such a compact design.
- [EASY TOUCH CONTROL] - We have designed three intuitive touch buttons on top for you. With these buttons, you can easily mute the desktop computer speaker and adjust the volume as you like.

December 11 on orders shipped by Amazon over \$35

Or fastest delivery Wednesday, December 10. Order within 7 hrs 37 mins

Delivering to Columbia 65202 - Update location

In Stock

Quantity: 1

Add to Cart

Buy Now

Ships from Amazon

Sold by XKX Direct

Returns FREE refund/replacement until Jan 31, 2026

Payment Secure transaction

Add a gift receipt for easy returns

Add to List



LIELONGREN [Newer] USB Com...  
4.3 5,043  
\$16.98

Delivering to Columbia 65202  
Update location

Office Products ▾ SWANCROWN enclosed case cork board

EN ▾ Hello, sign in  
Account & Lists ▾

Subtotal  
\$519.99

Office Products Office Deals School Supplies Printers, Ink & Toner Projectors Amazon Business

Go to Cart

Shop Mifuro

Sponsored

\$519.99

Office Products ▾ Office & School Supplies ▾ Presentation Boards ▾ Bulletin Boards

# SWANCROWN Weather Resistant Enclosed Bulletin Board Cork Displays Case Wall Mounted Notice Cabinet with Three Lockable Doors, 70x36 inches

The S SWANCROWN Store (162)

Amazon's Choice

\$495.99

Delivery & Support

Click to learn more

Ships from Amazon Returns until Jan 31, 2026 Customer Support

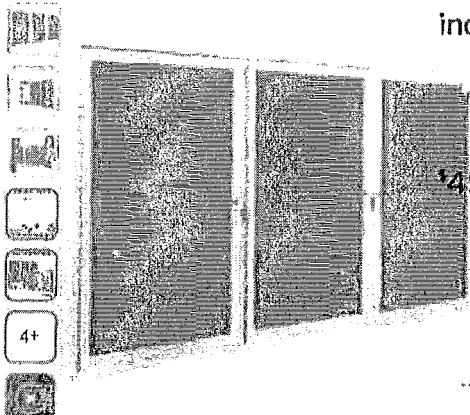

5 VIDEOS

Click to see full view

Color: Silver



\$485.99

\$495.99

Size: 70"x36"

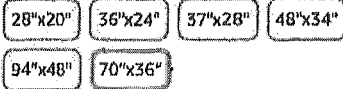

Material Acrylic, Aluminum, Cardboard, Cork

Color Silver

Brand S SWANCROWN

Size 70"x36"

Item Weight 20 Kilograms

## About this item

- **OUTDOOR USE** —The weather-resistant cabinet construction features an aluminum frame with a smooth surface and full-length piano hinges that add strength and durability to the door frame. Drain holes on the bottom and a sealed backing mean you can mount the board outdoors.
- **PIN EVERYTHING** —It has a soft, resistant and self-healing surface, made of eco-friendly cork. Hold your pins firmly in place so you can post notes, messages, pictures, memos, calendars, and stickers without worrying about pins falling out (100 push pins included).
- **SAFE DISPLAY** —The clear and shatter-resistant windows provide plenty of visibility in high traffic or public. It's convenient to post and update notice documents under the protection of lockable doors



Enjoy fast, free delivery, exclusive deals, and award-winning movies & TV shows.

Join Prime

\$495.99

FREE delivery Thursday, December 11

Delivering to Columbia 65202  
Update location

In Stock

Quantity: 1

Add to Cart

Buy Now

Ships from Amazon  
Sold by Swan Sea  
Returns Returnable until Jan 31, 2026  
Payment Secure transaction

Add a gift receipt for easy returns

Add to List

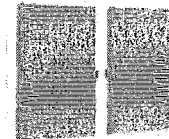

Enclosed Bulletin Board with Loc...

4.4 20

\$243.99

Sponsored

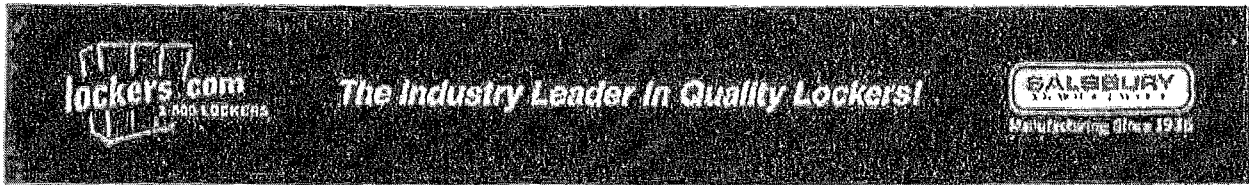

[Back to top of page](#)

**BULK PRICING**

**Get a Quote!**



[View all products](#)

## Shopping Cart

Cart #: 4KEO3246728676

Description	Unit Price	Quantity	Total	Edit
 <p><b>Wood Locker Bench - 36 Inches - 14 Inches Deep - Dark Finish - Free Standing</b>            Model: 14-77783DRK-FS            Color: Dark Bench            Bench Width: 36" Wide            Bench Depth: 14" Deep</p>	\$325.00 \$295.00	2	\$590.00	<a href="#">Edit Item</a> <a href="#">Remove</a>

[Privacy](#) • [Terms](#)

[Update Shopping Cart](#)

### CUSTOMER SERVICE

Contact our customer service department if you need help with the checkout process.

Monday - Friday 6:00am - 5:00pm PST | Tel: 1-800-LOCKERS(1-800-562-5377)

Your shopping cart # is: 4KEO3246728676

Cart Summary

<b>ENTER PROMO CODE</b>		Apply
<b>Subtotal:</b>		<b>\$590.00</b>
<b>Est. Shipping:</b> <a href="#">enter zip code</a>		<b>\$159.76</b>
<b>Est. Grand Total:</b>		<b>\$749.76</b>

**Total Savings \$60.00**

Sales taxes, if applicable, will be calculated when address information is completed.

Cart Tools

- [Clear Cart](#)
- [Save Your Cart](#)
- [View Saved Cart](#)
- [Need Help with your Order?](#)

- [About Salsbury Industries](#)
- [Manufacturing Since 1936](#)
- [Careers](#)
- [Driving Directions](#)
- [Factory Showroom](#)
- [FAQ's](#)

- [Customer Service](#)
- [Buyer's Guide](#)
- [Catalog Quick Order](#)
- [Contact Us](#)
- [Installation Instructions](#)
- [Order Status](#)



American Digital Security  
 140 Westwoods Dr.  
 Liberty MO 64068  
 United States  
 (816) 415-4237

Estimate  
 #EST0020118  
 01/05/2026

**Bill To**  
 Facilities Security /  
 hhowell108165  
 Boone County Facilities  
 Management  
 613 East Ash St  
 Columbia MO 65201  
 United States

**Ship To**  
 Facilities Security /  
 hhowell108165  
 Boone County Facilities  
 Management  
 613 East Ash St  
 Columbia MO 65201  
 United States

**TOTAL**

**\$3,889.84**

Expires: 02/19/2026

<b>Terms</b>	<b>Expires</b>	<b>PO #</b>	<b>Sales Rep</b>	<b>Title</b>	<b>Memo</b>
Due on receipt	02/19/2026		Christopher M Williams	SD Training	

Quantity	Item	Options	Rate	Amount
3	<b>1006CS-630</b> 1006 Series Electric Strike For Latchbolt Locks and Deadbolts, Fall Secure, Satin Stainless Steel Finish		\$667.14	\$2,001.42
2	<b>5200C-630</b> ELECTRIC STRIKE KIT W/ 501 & 501A OPTION		\$177.89	\$355.78
2	<b>40NKS-00-000000</b> SIGNO 40, BLK/SLVR, PTG, CRD PFL STD, MA RDY, FMT: ASP10022, WIEG, 32-B MSB, EM: 32-B, LED: RED, FLSH: GRN, BZR, SRF: ON, IPM: OFF, VEL: OFF, TAP		\$323.99	\$647.98
14	<b>H5A-FE-MT-NPTA1</b> NPT Adapter For H5A Fisheye Dome Camera		\$63.19	\$884.66

<b>Subtotal</b>	\$3,889.84
<b>Tax Total (\$)</b>	\$0.00
<b>Total</b>	\$3,889.84



EST0020118

## Leasa Quick

---

**From:** Aaron Neugarten  
**Sent:** Wednesday, December 31, 2025 8:11 AM  
**To:** Leasa Quick; Jean Meyer; Henry Howell  
**Subject:** RE: Owners Cost invoice ADS

Yes, I will take care of it.

Leasa, are you preparing a new BA for more expenses? If so, please add this to it.

Thank you,

**Aaron Neugarten** – Accountant II

Auditor's Department / Boone County Government, Missouri  
801 E. Walnut Street, Room 304 / Columbia, MO 65201  
tel: 573.886.4276  
[aneugarten@boonemo.gov](mailto:aneugarten@boonemo.gov)

**From:** Leasa Quick <[LQuick@boonemo.gov](mailto:LQuick@boonemo.gov)>  
**Sent:** Tuesday, December 30, 2025 3:59 PM  
**To:** Jean Meyer <[JMeyer@boonemo.gov](mailto:JMeyer@boonemo.gov)>; Aaron Neugarten <[ANEugarten@boonemo.gov](mailto:ANEugarten@boonemo.gov)>; Henry Howell <[HLHowell@boonemo.gov](mailto:HLHowell@boonemo.gov)>  
**Subject:** RE: Owners Cost invoice ADS

Aaron is the signer for this account.  
Aaron, do you need this to be on the next BA?

**From:** Jean Meyer <[JMeyer@boonemo.gov](mailto:JMeyer@boonemo.gov)>  
**Sent:** Tuesday, December 30, 2025 3:57 PM  
**To:** Aaron Neugarten <[ANEugarten@boonemo.gov](mailto:ANEugarten@boonemo.gov)>; Henry Howell <[HLHowell@boonemo.gov](mailto:HLHowell@boonemo.gov)>; Leasa Quick <[LQuick@boonemo.gov](mailto:LQuick@boonemo.gov)>  
**Subject:** RE: Owners Cost invoice ADS

Is someone going to pay this invoice? (regular payment since not part of PO)

Thank you,

**Jean Meyer** - Administrative Assistant  
Facilities Management/Boone County Government  
613 E Ash St., Columbia, Mo. 65201  
573-886-4400  
[jmeyer@boonemo.gov](mailto:jmeyer@boonemo.gov)

**From:** Aaron Neugarten <[ANEugarten@boonemo.gov](mailto:ANEugarten@boonemo.gov)>  
**Sent:** Tuesday, December 30, 2025 3:47 PM  
**To:** Henry Howell <[HLHowell@boonemo.gov](mailto:HLHowell@boonemo.gov)>; Jean Meyer <[JMeyer@boonemo.gov](mailto:JMeyer@boonemo.gov)>; Leasa Quick

<[LQuick@boonemo.gov](mailto:LQuick@boonemo.gov)>

**Subject:** RE: Owners Cost Invoice ADS

Henry,

Thank you for the update. Please give me a heads up if it is a substantial amount that may warrant a budget amendment.

Thank you,

**Aaron Neugarten** – Accountant II

Auditor's Department / Boone County Government, Missouri

801 E. Walnut Street, Room 304 / Columbia, MO 65201

tel: 573.886.4276

[aneusarten@boonemo.gov](mailto:aneusarten@boonemo.gov)

---

**From:** Henry Howell <[HLHowell@boonemo.gov](mailto:HLHowell@boonemo.gov)>

**Sent:** Tuesday, December 30, 2025 3:00 PM

**To:** Jean Meyer <[JMeyer@boonemo.gov](mailto:JMeyer@boonemo.gov)>; Aaron Neugarten <[ANEugarten@boonemo.gov](mailto:ANEugarten@boonemo.gov)>; Leasa Quick <[LQuick@boonemo.gov](mailto:LQuick@boonemo.gov)>

**Subject:** RE: Owners Cost Invoice ADS

It was not part of the PO, this was a last-minute change to get the door access panels installed – there wasn't enough room for a third enclosure in Mech136 unfortunately.

I will have another purchase coming up, that one is not as time sensitive – I can get that quote over to you next week when my ADS rep is back from vacation.

**From:** Jean Meyer <[JMeyer@boonemo.gov](mailto:JMeyer@boonemo.gov)>

**Sent:** Tuesday, December 30, 2025 2:44 PM

**To:** Aaron Neugarten <[ANEugarten@boonemo.gov](mailto:ANEugarten@boonemo.gov)>; Leasa Quick <[LQuick@boonemo.gov](mailto:LQuick@boonemo.gov)>

**Cc:** Henry Howell <[HLHowell@boonemo.gov](mailto:HLHowell@boonemo.gov)>

**Subject:** RE: Owners Cost Invoice ADS

I have no idea. I am not involved in that PO. I am including Henry

Thank you,

**Jean Meyer** – Administrative Assistant

Facilities Management/Boone County Government

613 E. Ash St., Columbia, Mo. 65201

573-886-4400

[jmeyer@boonemo.gov](mailto:jmeyer@boonemo.gov)

---

**From:** Aaron Neugarten <[ANEugarten@boonemo.gov](mailto:ANEugarten@boonemo.gov)>

**Sent:** Tuesday, December 30, 2025 2:42 PM

**To:** Jean Meyer <[JMeyer@boonemo.gov](mailto:JMeyer@boonemo.gov)>; Leasa Quick <[LQuick@boonemo.gov](mailto:LQuick@boonemo.gov)>

**Subject:** RE: Owners Cost Invoice ADS

Jean,

We just paid PO #2025-242 to ADS which is for the training center. Was this not part of the PO?

Thank you,

**Aaron Neugarten** – Accountant II

Auditor's Department / Boone County Government, Missouri  
801 E. Walnut Street, Room 304 / Columbia, MO 65201  
tel: 573.886.4276  
[aneugarten@boonemo.gov](mailto:aneugarten@boonemo.gov)

**From:** Jean Meyer <[JMeyer@boonemo.gov](mailto:JMeyer@boonemo.gov)>  
**Sent:** Tuesday, December 30, 2025 2:16 PM  
**To:** Leasa Quick <[LQuick@boonemo.gov](mailto:LQuick@boonemo.gov)>  
**Cc:** Aaron Neugarten <[ANEugarten@boonemo.gov](mailto:ANEugarten@boonemo.gov)>  
**Subject:** Owners Cost Invoice ADS

Hello

Attached is an invoice that was just received, although dated 11/21/25. Henry states this is owner's cost. Do you want to process the payment with correct coding.

Thank you,

**Jean Meyer** - Administrative Assistant  
Facilities Management/Boone County Government  
613 E Ash St., Columbia, Mo. 65201  
573-886-4400  
[jmeyer@boonemo.gov](mailto:jmeyer@boonemo.gov)

Delivering to Columbia 65202  
Update location

All swivel casters set of 4

EN Hello, sign in Account & Lists Returns & Orders 1

Subtotal \$519.99

Go to Cart

All Holiday Gifts Amazon Haul Medical Care Luxury Best Sellers

Industrial & Scientific Janitorial & Facilities Safety Supplies Medical Supplies Food Service Diagnostic Equipment Material Handling Educational Supplies

Shop FEVERSWIRE CASTERS

Sponsored \$519.99

Industrial & Scientific > Material Handling Products > Casters > Plate Casters

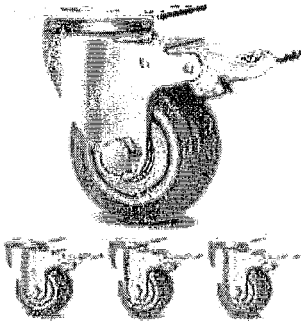

Click to see full view

### 3 Inch Industrial Heavy Duty Swivel Caster Wheels with Brake, Set of 4 Safety Locking Casters, Load 1600lbs, Premium Polyurethane Wheels for Table, Trailer, Saw Table, Stage Toolbox, Bed, Corn Board

Visit the TABKEER Store

4.8 (543)

Overall Pick

900+ bought in past month

-13% \$19.99

Typical price: \$22.99

Get Fast, Free Shipping with Amazon Prime

FREE Returns

Color: Red

		See 1 options with no featured offers
\$19.99 <del>\$22.99</del>	\$19.99 <del>\$22.99</del>	

Size: 3Inch

3Inch 4Inch 2Inch 5Inch

**Color** Red  
**Brand** TABKEER  
**Material** Polyurethane  
**Item Weight** 2.65 Kilograms  
**Mounting Type** Plate Mount

#### About this item

- [Rotate 360 degrees] Smooth & Silent & Sturdy. The total locking brake locks both the wheel and the swivel.
- [Multiple uses] can be installed in hand trailers, workbenches, tables, beds, wardrobes, building scaffolding, etc.
- [Double bearing] high-quality high carbon steel material and steel ball, the long service life of rolling contact. There is almost no resistance to taxiing.
- [Quiet wheel] Made of polyurethane material to reduce tire noise, tread width 1 2/11", wear-resistant.
- [Heavy-Duty] The load weight of each wheel can reach 400LBS, the mounting surface size is 3.7 x 2.5", the screw hole size is 0.32 x 0.46"



Enjoy fast, free delivery, exclusive deals, and award-winning movies & TV shows.

Join Prime

\$19.99

Get Fast, Free Shipping with Amazon Prime

FREE delivery Thursday, December 11 on orders shipped by Amazon over \$35

Or fastest delivery Tuesday, December 9. Order within 6 hrs 32 mins

Delivering to Columbia 65202 - Update location

In Stock

Quantity: 1

Add to Cart

Buy Now

Ships from Amazon

Sold by TABKEER

Returns 90 days  
return/replacement until Jan 31, 2025

Packaging Ships in product packaging

See Prime

Add a gift receipt for easy returns

Add to List



**secureWESTERNstorage**  
 Secure Western Storage Inc.  
 1534 N. Moorpark Rd, #358  
 Thousand Oaks, CA 91360  
 Cage: 7MD21 DUNS: 79755214

**\*\* QUOTATION \*\***

QUOTE: 12583

DATE: 1/6/2026

Bill To:

Ship To:  
 Regional Training Center  
 2013 E County Dr  
 Columbia, MO 65202

QTY	PART NO.	DESCRIPTION	PRICE EACH	EXTENDED	WEIGHT (LBS)
2	050-98500	5 Drawer Pistol/Storage Cabinet w/ Abloy Lock	\$1,802.45	\$3,604.90	602
5	050-98530	30 Capacity Pistol Insert	\$335.40	\$1,677.00	0
5	050-98510	Left to Right Divider - Large	\$24.05	\$120.25	0
140	050-98515	Compartment Divider - Small	\$5.85	\$819.00	0
1	050-94084	84" Bi-Fold SWR w/ Gate	\$1,810.25	\$1,810.25	270
24	050-92501	1 Capacity Barrel Saddle - 5.5"	\$11.70	\$280.80	24
24	050-92401	1 Capacity Stock Saddle	\$11.70	\$280.80	24
1	050-92312	12 Capacity Stock Shelf w/ Stiffener	\$117.65	\$117.65	16
2	050-90001	ABLOY Lock & 2 Keys	\$79.30	\$158.60	2
1	050-90005	ABLOY Master Key	\$27.95	\$27.95	0

Total Weight (lbs) 938

<b>Subtotal</b>	<b>\$8,897.20</b>
Sales Tax (0%)	\$0.00
S&H	\$1,050.53
Installation	\$0.00
<b>Total</b>	<b>\$9,947.73</b>

**Notes:**  
 \*Lead time is currently 4-6 Weeks ARO  
 \* Thank you for the opportunity to quote this project.  
 \*Quote is valid for 30 days.

Submitted By: Steven Roeder ----- sroeder@securewesternstorage.com ----- 757-778-0433

# Pistol & Magazine Storage Cabinet

Safely store your pistols, mags, bolts, batons and more. This purpose built Storage Cabinet keeps your weapon storage area organized and secure. The cabinet has a secure Interlock mechanism (Abloy) and the body is fully welded 16 gauge steel construction with a durable powder coat paint finish.

**SECURELY STORE UP TO 160 PISTOLS  
AND MAGAZINES IN ONE CABINET**

**45" H x 41.5" W x 25" D**

## DRAWER INSERT OPTIONS

Order the cabinet that's right for you with 5 pre-configured drawer inserts and divider options.

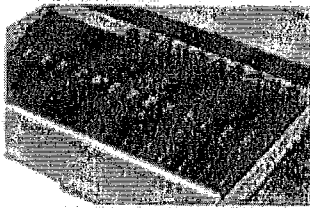

**Pistol & Mag Insert**  
30 Capacity

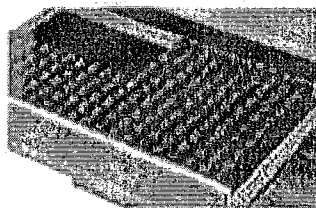

**Pistol Magazine Insert**  
200 Capacity

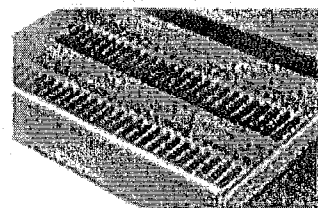

**Rifle Bolt Insert**  
50 Capacity

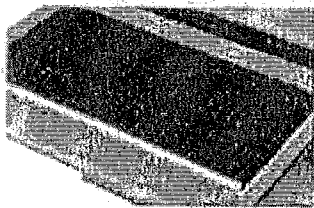

**Baton Insert**  
50 Capacity

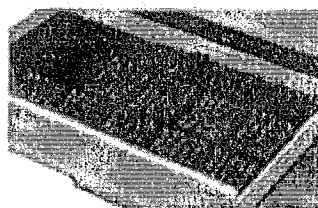

**Rifle Magazine Insert**  
85 Capacity

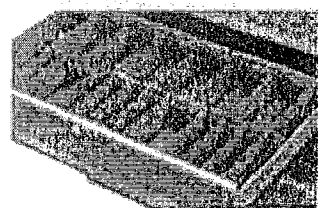

**Storage Dividers**  
Adjustable

 **DASCO**  
storagesolutions

EMAIL [info@dascostorage.com](mailto:info@dascostorage.com)  
WEBSITE [www.dascostorage.com](http://www.dascostorage.com)  
PHONE 800-387-2468

Scotty's Signs  
 3400 S BILLY JEAN DR  
 MO 65202

# Estimate

Date	Estimate #
1/7/2026	6

Name / Address
Boone County Sheriff Office 2121 County Drive Columbia, Mo 65202 573-875-1111

Project

Description	Qty	Rate	Total
Training Center Entrance Signage	1	90.00	90.00
Main Entrance with Left Arrow	1	90.00	90.00
Main Entrance with Right Arrow	1	90.00	90.00
Check In at Main Entrance	1	90.00	90.00
Do Not Enter	1	20.00	20.00
		<b>Subtotal</b>	\$380.00
		<b>Sales Tax (5.975%)</b>	\$0.00
		<b>Total</b>	\$380.00

# DEFENSE TARGETS

Quote

## Defense Targets LLC

9535 US 401  
Fuquay Varina, NC 27526  
shoot@defensetargets.com

INVOICE NO 1626  
DATE 1/6/26  
CUSTOMER ID Boone County Sheriff's Office

TO

SHIP TO

Justin Ludwig  
Boone County Sheriff's Office  
2111 East County Drive  
Columbia, MO 65202

Justin Ludwig  
Boone County Sheriff's Office  
2111 East County Drive  
Columbia, MO 65202

### PAYMENT TERMS

Quote - Tax Exempt

DESCRIPTION	QUANTITY	PRICE	TOTAL
MBT, Portable Rifle Rated Bullet Trap MBT Portable Rifle Ra... DFT-170-MOBBULLET-1	7.00	\$1,749.00	\$12,243.00
Discount - LE	1.00	-\$1,224.30	-\$1,224.30
Shipping: LTL Freight	1.00	\$800.00	\$800.00
		TOTAL DUE	\$11,818.70

Make all checks payable to Defense Targets LLC.

THANK YOU FOR YOUR BUSINESS!